

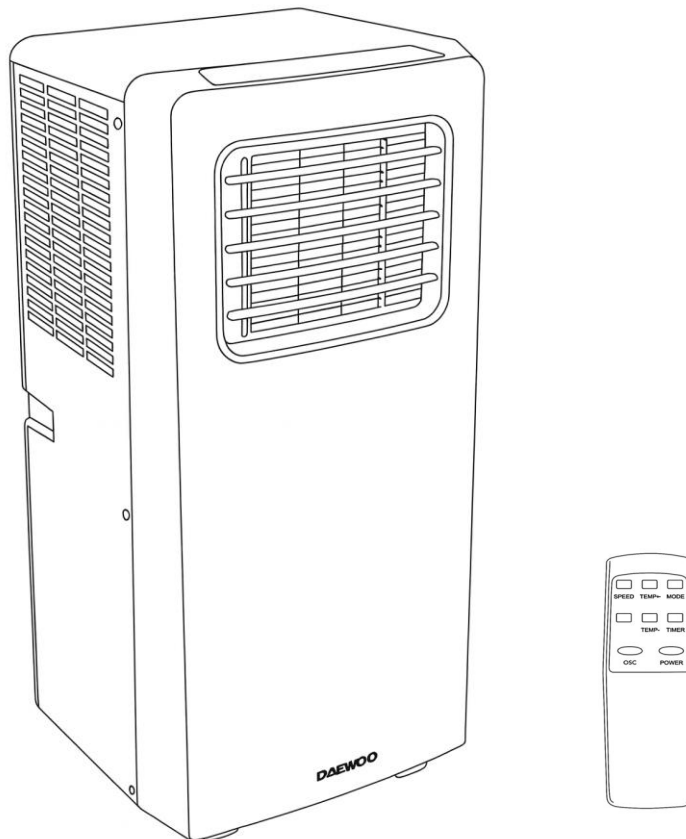

5000 Btu 3in1 Portable Air Conditioner

COL1316
User Manual



Page No.	
2	Contents
3	Getting Started
3-5	Safety Advice
6	Description of Symbols
7	What's in the Box
7	Description of the Main Unit
8	Description of the Control Panel
	Description of the Vent Kit
9	Description of the Remote Control
10-11	Fitting the Vent Kit
12	Operating Instructions
	Cooling Mode
	Dehumidifying Mode
	Fan Only Mode
	Oscillation Mode
13	Operating Instructions - Using the Timer
	Timed ON Setting
	Timed OFF Setting
	Changing °C to °F
14	The Remote Control
	Inserting the Batteries
	Using the Remote Control
15	Battery Safety
16	The Internal Water Tank and draining
	Causes of excessive tank fill
	Safety shut off
17	Cleaning the Air Filter
	Care and Cleaning
	Technical Specification
18	Troubleshooting
	Recycling
19	Mains Plug
	Customer Support
	Safety Marks
20	Warranty

- Check that the product is intact and undamaged and all parts are present.
- Some assembly of your Air Conditioner is required but no tools are required.
- The Remote Control requires 2x 1.5V AAA batteries (not supplied).

Safety Advice

- **IMPORTANT** – The first step you need to take is to ensure your safety! Please take time to read and understand these instructions before using the product.
- Please keep these instructions for future reference.
- This appliance can be used by children from 8 years and above and persons with reduced physical, sensory or mental capabilities or lack of experience or knowledge if they have been given supervision or instruction concerning use of the appliance in a safe way and understands the hazards involved. Children shall not play with the appliance. Cleaning and user maintenance shall not be made by children unless they are older than 8 years and with supervision.
- Close supervision is required when using this appliance near children.
- Keep the appliance and its cord out of reach of children less than 8 years.
- Children of less than 3 years should be kept away unless continuously supervised.
- **DO NOT** immerse the appliance or its cord in water or any other liquids.
- Always use this appliance on solid, level, surface.
- **DO NOT** use this appliance outdoors.
- Repairs to electrical appliances should be performed by a qualified electrician. Improper repairs may place user at serious risk.
- **DO NOT** operate this appliance with a damaged plug or cord, after a malfunction or after being dropped or damaged in any way.
- If the power cable is damaged, it should only be replaced by the manufacturer or a suitable qualified-after-sales service in order to avoid a hazard.





- **DO NOT** use any accessories or attachments with this appliance other than those supplied or recommended by the supplier.
- **DO NOT** use this appliance for anything other than intended use.
- **DO NOT** push objects (including fingers) into the grill or any openings as this could risk injury or damage to the appliance.
- Always unplug from the mains supply after each use when not in use. Grasp the plug not the cord.
- **DO NOT** leave this appliance unattended when in use.
- Check that the voltage indicated on the data plate corresponds with that of the local network before connecting the appliance to the mains power supply.
- Disconnect the power plug from the socket before dismantling, assembling or cleaning.
- The air conditioner must always be stored and transported upright, otherwise irreparable damage may be caused to the compressor; if in doubt, wait at least 24 hours before restarting the unit.
- Avoid restarting the air conditioner unless 3 minutes have passed since being turned off. This prevents damage to the compressor.
- **DO NOT** use the mains plug or external timer as a means of switching the air conditioner on or off. Use the ON/OFF button located on the control panel.
- Always place the unit on a dry and stable surface.
- The appliance should not be placed in a bath, laundry or wet room.
- The appliance must be placed in a room without sources of ignition (for example: open flames, an operating gas appliance or an operating electric heater)
- The appliance must be installed and used in a room with a floor area larger than 4m²
- This appliance contains R290 refrigerant gas. For quantity see the rating label on the rear of the unit.
- R290 refrigerant gas complies with EU environmental directives.

- Refrigerant gas may be odourless, if the appliance is used or stored in an unventilated room, the room must be such as to prevent stagnation of possible leaks of refrigerant gas as there could be a danger of fire or explosion hazard should the refrigerant come into contact with electric heaters, stoves or other sources of ignition.
- The refrigerant system should not be perforated.
- The appliance must be stored in such a way as to prevent mechanical failure.
- Individuals who operate or work on the refrigerant circuit must have the appropriate certification issued by an accredited organisation that ensures competence in handling refrigerants according to a specific evaluation recognized by associations in the industry.
- Repairs must be performed based on the recommendation from the manufacturing company. Maintenance and repairs that require the assistance of other qualified persons must be performed under the supervision of an individual specified in the use of flammable refrigerants.

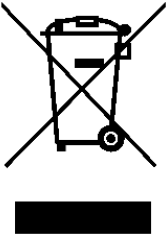
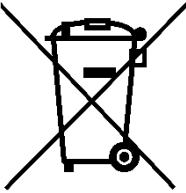

- The air conditioner will defrost on occasions, do not use any tools or heaters to speed up this process as this may cause damage to the appliance.
- Do not use means to accelerate the defrosting process or to clean, other than those recommended by the manufacturer.
- The appliance shall be stored in a well-ventilated area where the room size corresponds to the room area as specified for operation.
- All working procedures that affect safety shall only be carried out by competent persons.

The following warning symbols or words are used in this instruction manual:

	<p>Products labelled with UK Conformity Assessment identifies products conforming to UK statutory requirements</p>
	<p>Products labelled with this symbol conform to applicable provisions of the European Economic Area.</p>
	<p>You should now recycle your waste electrical goods and in doing so help the environment. This symbol means waste electrical products at the end of their useful life should not be disposed of with normal household waste and not sent to landfill. Please ensure it is taken to a suitable facility for disposal. Check with your Local Authority or retailer for recycling advice or visit www.recycle-more.co.uk or www.weeeireland.ie enter your postcode to find out your nearest recycling site.</p>
	<p>This symbol means batteries and rechargeable batteries may not be disposed of with household waste! As the end user you are required by law to bring all batteries and rechargeable batteries to a collection point run by the Local Authority or to a retailer, so that they can be disposed of in an environmentally friendly manner.</p>
	<p>This symbol indicates that the supply uses an alternating current mains supply.</p>
<p>WARNING!</p>	<p>This designates a hazard with moderate risk, which may result in severe injury or damage to the product if not adhered to.</p>
	<p>This symbol indicates that the product is class I and therefore requires an earth connection.</p>

- Air Conditioner
- Remote Control
- Flexible Hose
- Hose Connector
- Hose Outlet Ring
- Hose Outlet Ring with Grill
- User Manual (This Booklet)

Description of the Main Unit

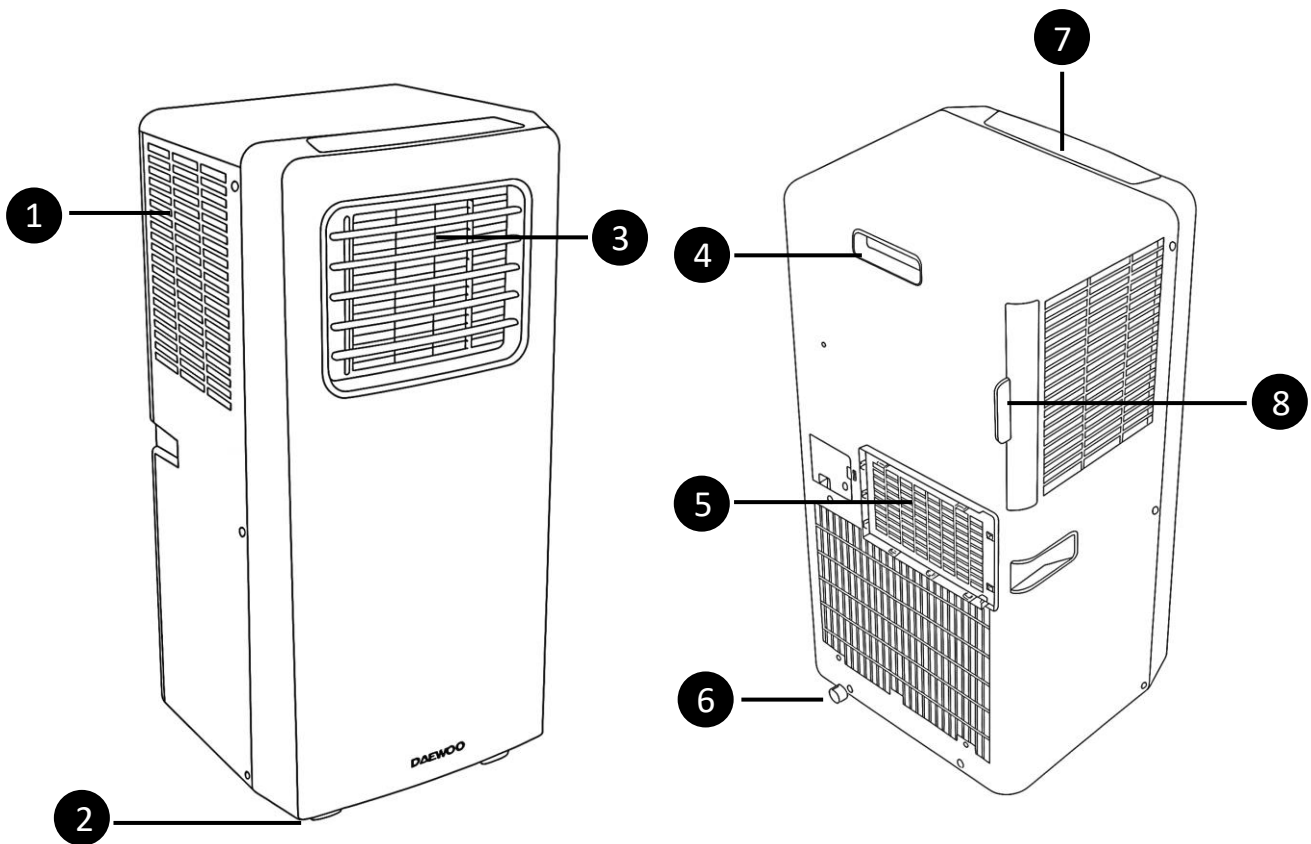

1. Air Inlet Grill
2. Castors (x4)
3. Air Outlet
4. Handle
5. Exhaust
6. Tank Drain
7. Control Panel
8. Air Filter Handle
9. Remote Control

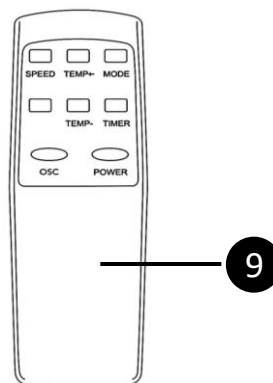

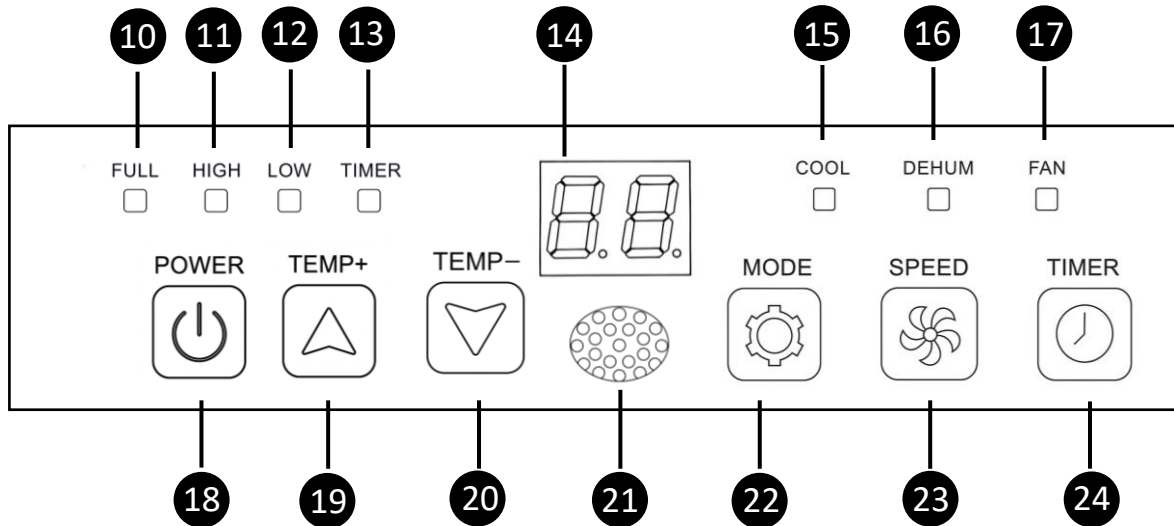

- 10. Water Full Indicator
- 11. High Fan Speed Indicator
- 12. Low Fan Speed Indicator
- 13. Timer Indicator
- 14. LED Display
- 15. Cool Mode Indicator
- 16. Dehumidify Mode Indicator
- 17. Fan Only Indicator

- 18. Power ON/OFF Button
- 19. Temperature/Time + Button
- 20. Temperature/Time – Button
- 21. Remote Signal Receiver
- 22. Mode Button
- 23. Fan Speed Button
- 24. Timer Button

Description of the Vent Kit

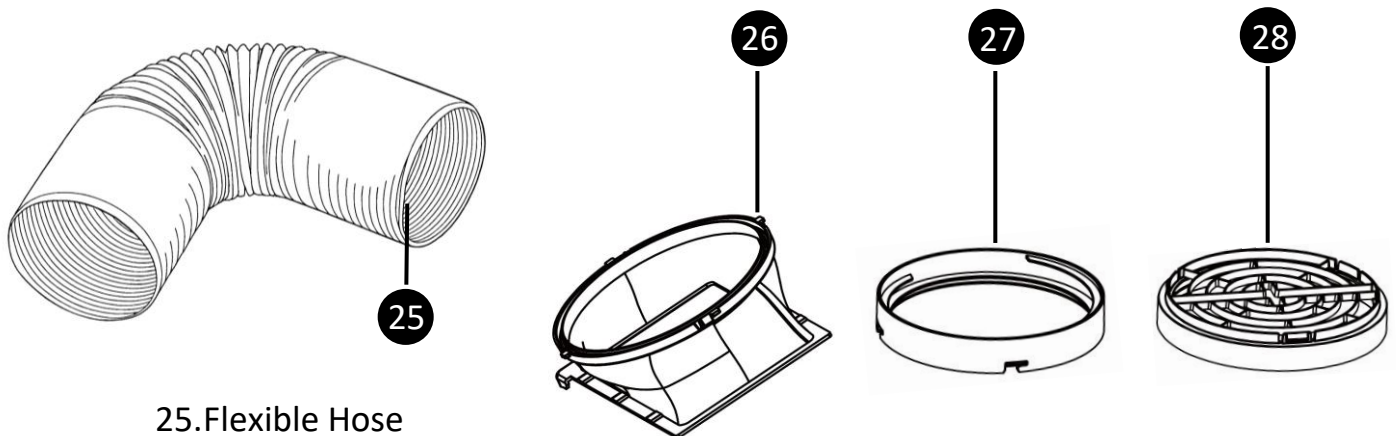

- 25. Flexible Hose
- 26. Hose Connector
- 27. Hose Outlet Ring
- 28. Hose Outlet Ring with Grill

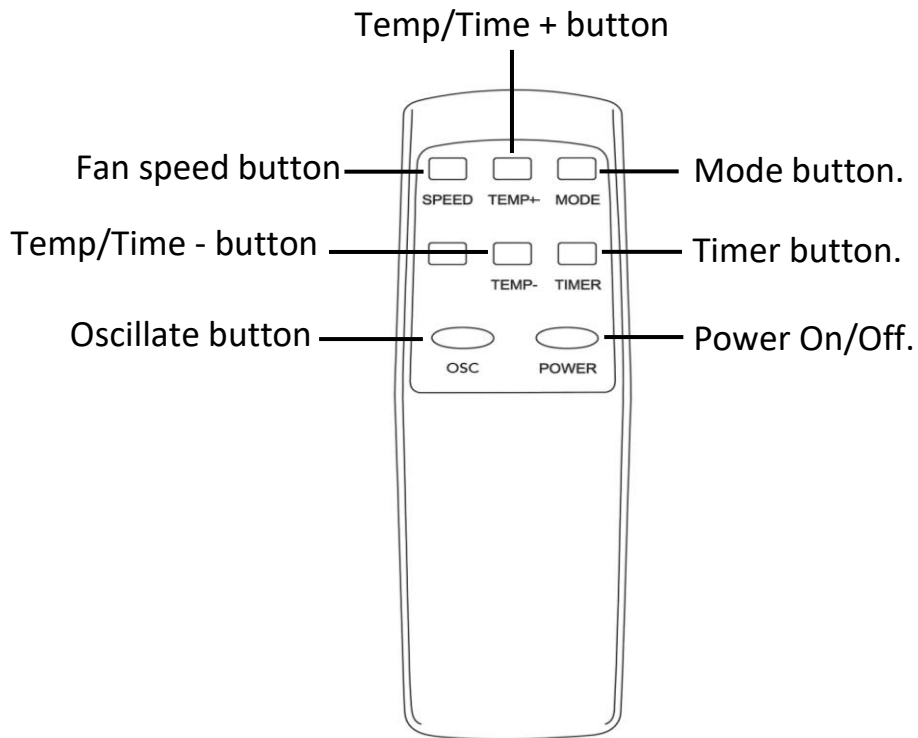

Step 1

Attach the Hose Connector (26) to the end of the Flexible Hose (25) by first Extending one end of the Flexible Hose (25) by about 10cm/4 Inches.

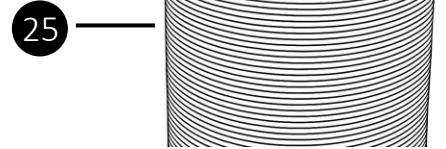
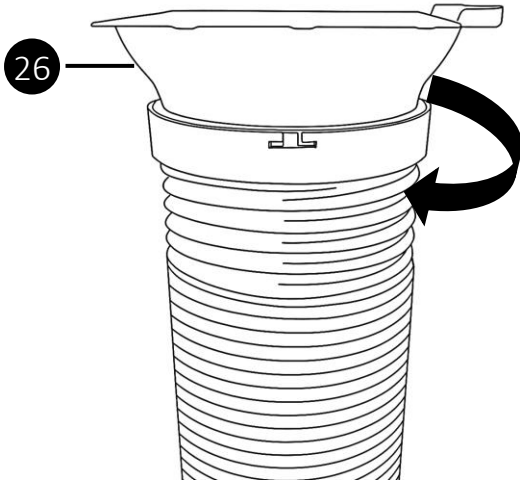

Step 2

Screw the Hose Connector (26) onto the end of the Flexible Hose (25) in a clockwise direction.

Step 3

Attach the Hose Outlet Ring (27) to the end of the Flexible Hose (25) by first Extending the other end of the Flexible Hose (25) by about 10cm/4 Inches

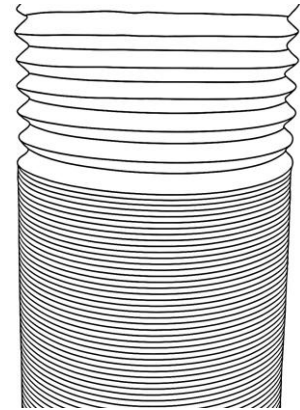
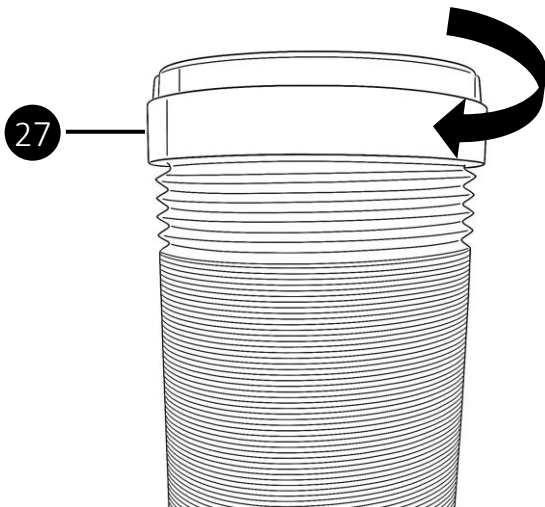

Step 4

Screw the Hose Outlet Ring (27) or the Hose Outlet Ring with Grill (28) onto the other end of the hose in a clockwise direction.

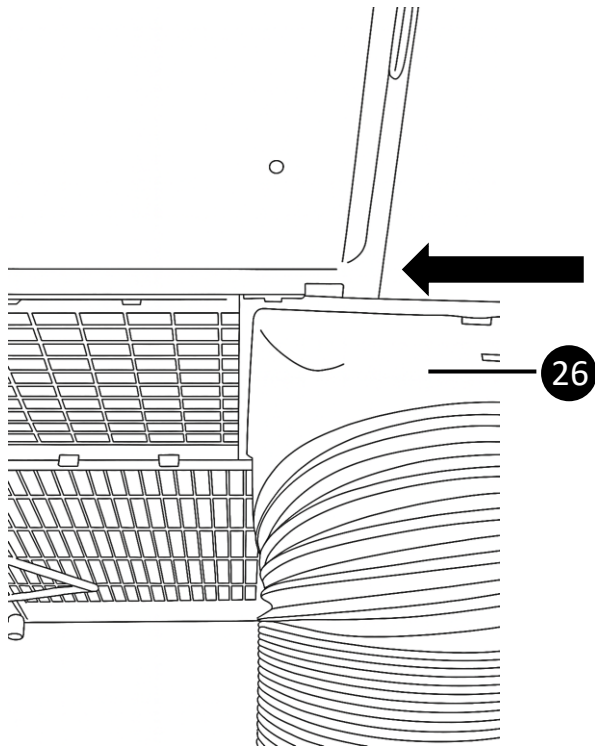

Step 5
Slide the Hose Connector (26) into the slot on the rear of the unit with the Catch (a) on the right hand side.

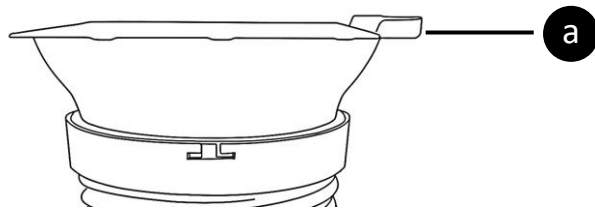

Step 6
Slide the Hose Connector (26) left until it locks into place.

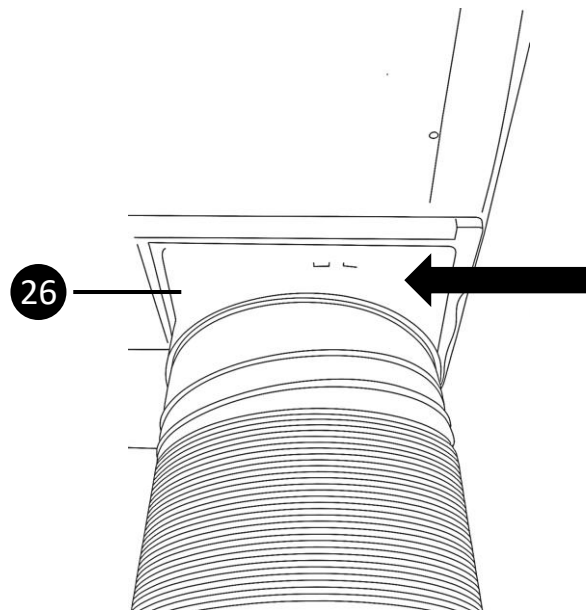

Place the outlet end of the Flexible Hose (25) through a suitable outlet such as an open window, door, etc.
NB The unit must be positioned a minimum of 1 Metre away from any wall or obstruction on all sides.

Insert the mains plug into the nearest socket.

Choose from one of the following modes:

Cooling Mode

1. Power the unit up by pressing the Power On/Off Button (18).
2. Press the Mode Button (22) until the 'COOL' Indicator (15) illuminates.
3. Press the Temp + (19) and Temp – (20) Buttons to select the desired room temperature (16°C - 31°C) on the LED Display (14).
4. Press the Fan Speed Button (23) to choose either low or high fan speeds, the selected speed will be shown by the Fan Speed Indicators HIGH (11) or LOW (12).

Dehumidifying Mode

1. Power the unit up by pressing the Power On/Off Button (18).
2. Press the Mode Button (22) until the 'DEHUM' Indicator (16) illuminates.

NB The unit will automatically set the temperature to 2°C below the room temperature and the fan speed to low and begin dehumidifying.

Fan Only Mode

1. Power the unit up by pressing the Power On/Off Button (18).
2. Press the Mode Button (22) until the 'FAN' Indicator (17) illuminates.
3. Press the Fan Speed Button (23) to choose either low or high fan speeds, the selected speed will be shown by the Fan Speed Indicators HIGH (11) or LOW (12).

Oscillation Mode

1. Press the OSC button on the Remote Control (9) to select Oscillation Mode, this will enable the Air Outlet (3) to continually disperse air from side to side.
2. Press the 'OSC' button on the Remote Control (9) again to cancel Oscillate Mode.

NB Oscillation Mode is not available on the Control Panel (7).

Using the Timer

Timed 'on' Setting

1. With the unit off i.e., not powered up but plugged into the mains, press the Timer Button (24), the 'TIMER' Indicator (13) will illuminate to show the unit is in TIMER mode.
2. Next select how many hours you need before unit switches ON using the Temp + (19) and Temp – (20) Buttons.
3. The 'on' time will be displayed on the LED Display (14) as the number of hours until the unit switches on, up to a maximum of 24Hrs.
4. The LED Display (14) will flash whilst the time is being set. Once set, press the Timer Button (24) again to confirm the setting. The LED Display (14) will stop flashing and after a few seconds go dim.
5. The timer will count down the set time and the unit will switch on.

Timed 'off' Setting

1. Power the unit up by pressing the Power On/Off Button (18).
2. Press the Timer Button (24), the 'TIMER' Indicator (13) will illuminate to show the unit is in TIMER mode.
3. Next select how many hours you need before unit switches OFF using the Temp + (19) and Temp – (20) Buttons.
4. The 'off' time will be displayed on the LED Display (14) as the number of hours until the unit switches off, up to a maximum of 24Hrs.
5. The LED Display (14) will flash whilst the time is being set. Once set, press the Timer Button (24) again to confirm the setting. The LED Display (14) will stop flashing and after a few seconds go dim.
6. The timer will count down the set time and the unit will switch off.

NB To cancel the timer, press Timer Button (24).

Changing °C to °F

Whilst the unit is running, press and hold the Temp + (19) and Temp - (20) buttons together until the LED Display (14) changes from showing degrees Centigrade to Fahrenheit. Repeat the process to return the display back to Centigrade.

Inserting the Batteries

First Insert the Batteries (not supplied) into the Remote Control (9).

Slide the battery compartment cover in the direction of the arrow and insert 2 x AAA 1.5V batteries observing the polarity marks inside the compartment. Slide the cover back on in the opposite direction once the batteries are fitted:

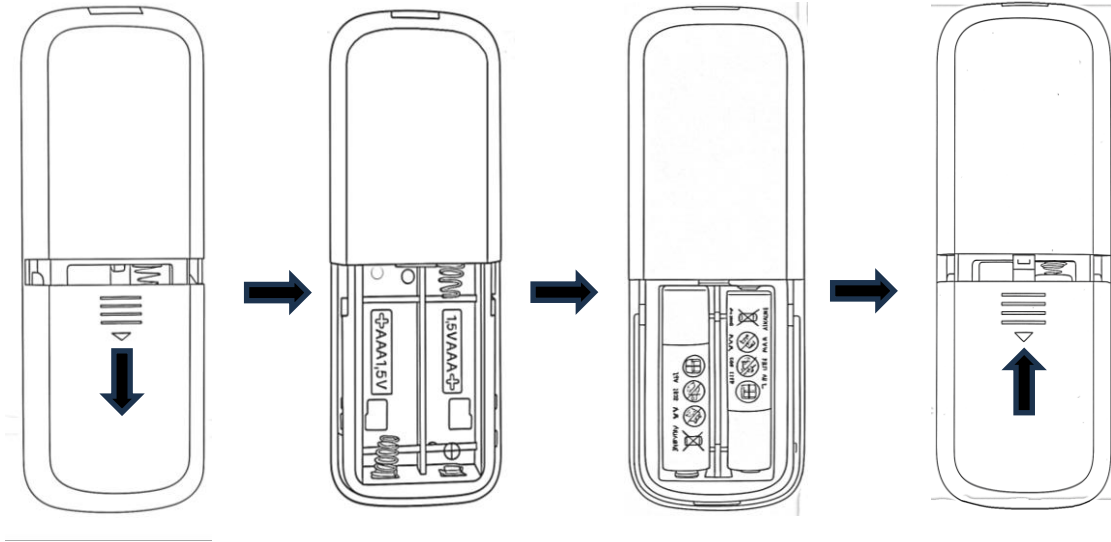

Using the Remote Control

The Remote Control (9) allows full functional use of the Air Conditioner plus the Oscillate feature:

- b. Press the SPEED button to select Low or High Fan Speeds.
- c. Press the TEMP+/- buttons to select the room temperature during 'Cool' mode and/or the time whilst setting the Timer.
- d. Press the OSC button to select Oscillation Mode, this will enable the Air Outlet (3) to continually disperse air from side to side. NB the Oscillate Mode is not available on the Control Panel (7).
- e. Press the MODE button to select between Cool, Dehumidifier or Fan modes.
- f. Press the TIMER button to enter timer mode.
- e. Press the POWER button to switch the unit on and off.

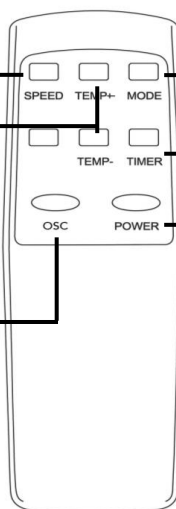

- CAUTION: There is a danger of explosion if the batteries are incorrectly fitted.
- Ensure that the batteries are installed with the correct polarity.
- It is recommended that batteries are removed if the remote is not to be used for a long period of time or if the remote is to be disposed of.
- Replace only with the same or equivalent battery type.
- Store batteries in a cool dry place.
- Do not expose the battery to sunshine, fire, heat or similar, never dispose of batteries in a fire.
- Do not charge non-rechargeable batteries.
- Do not short-circuit batteries.
- Do not mix old and new batteries.
- Exhausted batteries are to be removed from the product and safely disposed of.

WARNING!

- **DO NOT ingest the battery, Chemical Burn Hazard.**
- **Keep new and used batteries away from children.**
- **If the battery compartment does not close securely, stop using the product and keep away from children.**
- **If you think batteries may have been swallowed or placed inside any part of the body, seek immediate medical attention.**

During normal use, most of the moisture collected will be evaporated internally by the unit and expelled through the Exhaust (5).

However, eventually the internal water tank will fill to its maximum capacity and the Water Full (WF) Indicator (10) will illuminate on the Control Panel (7) to show the tank is full.

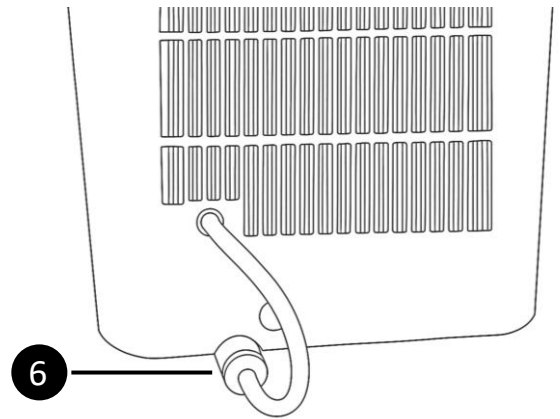

To empty the water tank, take the unit outside, remove the plug from the Tank Drain (6) at the bottom rear left of the unit and allow the tank to empty.
NB Ensure the plug is replaced before using the unit again.

Alternatively connect a hose (not supplied) to the Tank Drain (6) and lead it outside to the drain the tank continuously. Ensure that the hose is not raised above the level of the outlet and is not kinked or bent so that the tank can drain properly.

Possible Causes of Excessive Tank Fill

The amount of water collected by the tank and the frequency of draining is caused by the relative humidity levels which will vary and will depend on several factors:

1. Avoid placing the Air Conditioner near kitchens or bathrooms (and not in the bathroom!).
2. Drying washing in the same room as the Air Conditioner will increase tank fill.
3. Damp weather or high humidity will affect the amount of water collected especially when it is raining.

Safety Shut Off

This unit is fitted with an automatic high temperature shut off device, if the air inlet and/or exhaust are blocked the unit will shut down safely.

After clearing the blockage, allow 30 minutes for the unit to cool before restarting the unit.

The air filter is located behind the Air Inlet Grill (1) on the left hand side and will need occasional cleaning. To clean the air filter, remove the filter by pulling the Air Filter Handle (8) towards the rear of the unit.

The filter can be cleaned by vacuuming fluff, etc. with a regular vacuum cleaner. If the filter is particularly soiled, then it can be washed in lukewarm (40°C) water with a mild detergent. After washing, allow the filter to dry naturally, lay it flat to avoid stretching.

Ensure that the filter has thoroughly dried before refitting it to the unit.

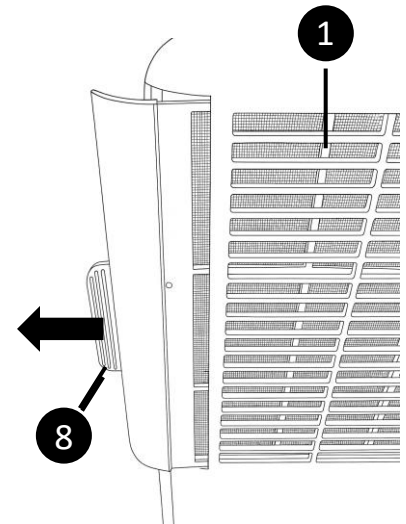

DO NOT use the Air Conditioner without the filter fitted otherwise serious damage may occur to the unit.

Care and Cleaning

- Ensure that the Air Conditioner is not connected to the mains supply before cleaning.
- We recommend cleaning the outer body with a soft dry cloth. Do not use abrasive materials as these will damage the finish.
- Do not immerse the unit or its cord in water or any other liquid.
- Excess dust etc. can be removed from grilles and exhaust using a vacuum cleaner.

Technical Specification

Model Number	COL1316
Supply Voltage	220-240V~ 50Hz
Rated Power	561W
Rated Current	2.6A
Protection Class	I (This Appliance Must Be Earthed)
Unpacked Weight	20 Kgs (approx.)
Cooling Capacity	5000BTU/h (1420W)
Refrigerant	R290 (100g)
Operating Pressure	Discharge 2.6MPa Suction 1.0MPa
Maximum Pressure	Discharge 3.2MPa Suction 1.2MPa
IP Rating	IP20
Sound Power Level	65dB (A)

Symptom	Possible Cause	Possible Solution
The unit does not power up	No power supply	Power on and turn on the unit
	Water tank is full	Drain the water tank
	Timer function is active	Cancel timer function
	Room temperature is too low	Reset temperature on unit
Unit not performing well	Unit is in direct sunlight	Shade the unit with curtains/blinds
	Filter is dirty	Remove and clean the filter
	Air inlet or outlet is blocked	Remove any blockage or debris from the inlet/outlet
Compressor not working	Overheat protection device has operated	Check venting then allow the unit to cool for 5 minutes before restarting
Remote control not working	Operating distance is too far	Move closer to the unit
	Batteries are flat	Replace batteries
Unit is noisy	The unit is located on an uneven surface	Position the unit on a flat level surface
E2 Code displayed	Water tank full	Drain the water tank
E0 Code displayed	Room temperature sensor failed	Contact Customer Support
E3 Code displayed	Evaporator temperature sensor failed	Contact Customer Support

Recycling

Disposal of the Packaging

Dispose of paper and cardboard in appropriate paper re-cycling facilities.
 Dispose of recyclable plastics in appropriate plastic re-cycling facilities.
 Dispose of non-recyclable plastics in the appropriate plastics collection service.

Disposal of the Product

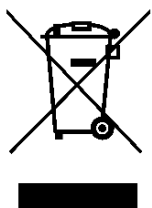

You should now recycle your waste electrical goods and in doing so help the environment. This symbol means waste electrical products at the end of their useful life should not be disposed of with normal household waste and not sent to landfill. Please ensure it is taken to a suitable facility for disposal. Check with your Local Authority or retailer for recycling advice or visit www.recycle-more.co.uk or www.weeeireland.ie, enter your postcode to find out your nearest recycling site.

This appliance is supplied with a non-rewireable plug fitted to the mains lead and should the fuse need replacing, you must use an ASTA approved one (conforming to BS 1362 of the same rating). Never use a mains plug with the fuse cover missing. If in doubt, consult a qualified electrician.

If the plug is to be removed – DISCONNECT FROM THE MAINS – and then cut it off the mains lead and immediately dispose of it safely. Never attempt to reuse the plug or insert it into a socket outlet as there is a danger of electric shock.

Customer Support

Should you require any product information, replacement parts or accessories, please contact our customer care team on 0161 831 7879 (8.30am-4.30pm Monday to Thursday, 8.00am-4.00pm Friday) and select option 3 or by contacting us via email: help@daewoelectricals.com.

- Replacement parts and accessories are guaranteed for 1 year from the date of purchase.
- It is important to note that your warranty becomes invalid should non Daewoo parts or accessories be used with this appliance.

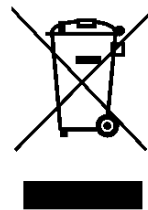

Thank you for purchasing your Daewoo product.

As part of our commitment to quality, we are offering you an extra 2 years warranty in addition to your 1 year guarantee

Your Daewoo product is guaranteed for 1 year from the date of original purchase, with proof of purchase or receipt. If any defect should occur due to faulty workmanship or materials, your faulty product should be returned to the place of purchase, replacement or refund is at the discretion of the retailer.

The guarantee is subject to the following provisions:

- The product must be correctly installed and operated in accordance with the requirements contained in the instruction manual.
- The product must be used solely for domestic purposes.
- It does not cover general wear and tear, damage, misuse or any consumable parts.
- The guarantee will be rendered invalid if the product is re-sold or has been damaged through inexpert repair.
- The guarantee is only valid within the UK and Eire.

Your standard 1 year guarantee will only be extended to the maximum available for your individual product upon registration. (Note: products must be registered individually and covers the main body and housing). If you do not register your product within 28 days of the original purchase date, your product will only be guaranteed for 1 year.

To validate your extended 2 year warranty* please register your purchase online within 28 days of the original purchase date by registering at:

<https://help.daewooelectricals.com>

or

[Contact Us \(daewooelectricals.com\)](https://www.daewooelectricals.com)

*Your extended warranty is only valid with proof of purchase receipt and subject to the conditions outlined above.

Daewoo is a registered trademark.
Produced and imported under licence by
Eurosonic Group Limited
Brightgate House
1 Brightgate Way
Manchester M32 0TB UK
EU Rep: EuroSonic Magppie (ESM) Ltd. Ireland D05 X006
www.esgltd.com
Made in China